

## 8831-KPL

- Mitlaufende Körnerspitze -  
Komplett-Satz mit austauschbaren  
Einsätzen
- Revolving tailstock centres  
with interchangeable inserts  
- set

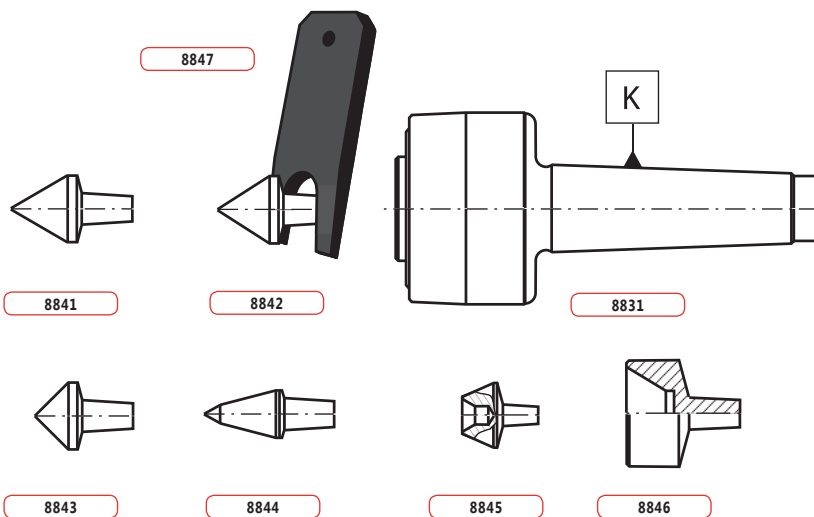

K MK	Gewicht max.	U/min.	Rundlaufabweichung	Artikel Nr.	Rundlaufabweichung	Artikel Nr.
			Max. concentr. error	Code No.	Max. concentr. error	Code No.
K MT	Max. weight	RPM	Präzision • Precision		Standard • Standard	
2	70	5000	0,010	800002610	0,020	800002611
3	120	4000	0,010	800002612	0,020	800002613
4	280	3000	0,010	800002614	0,020	800002615
5	650	2500	0,015	800002616	0,030	800002617
6	1200	2000	0,015	800002618	0,030	800002619

### 8841

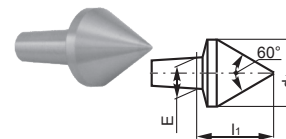

Artikel Nr. Code No.	W*	d <sub>1</sub>	E	l <sub>1</sub>
800002660	2	18	7	21,0
800002661	3	25	12	28,0
800002662	4	28	15	30,5
800002663	5	40	22	42,5
800002664	6	60	28	61,5

\*Größe \*Size

### 8842

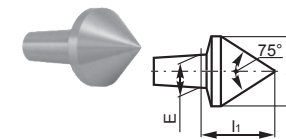

Artikel Nr. Code No.	W*	d <sub>1</sub>	E	l <sub>1</sub>
800002665	2	18	7	17,5
800002666	3	25	12	23,0
800002667	4	28	15	25,0
800002668	5	40	22	34,0
800002669	6	60	28	50,5

\*Größe \*Size

### 8843

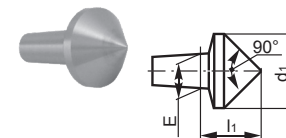

Artikel Nr. Code No.	W*	d <sub>1</sub>	E	l <sub>1</sub>
800002670	2	18	7	15,0
800002671	3	25	12	19,0
800002672	4	28	15	21,0
800002673	5	40	22	28,0
800002674	6	60	28	40,0

\*Größe \*Size

### 8847

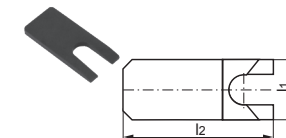

Artikel Nr. Code No.	W*	l <sub>1</sub>	l <sub>2</sub>
800002909	2	20	50
800002910	3	30	70
800002911	4	45	100
800002912	5	55	120
800002913	6	65	160

\*Größe \*Size

### 8844

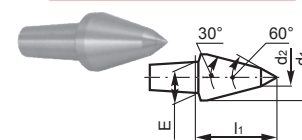

Artikel Nr. Code No.	W*	d <sub>1</sub>	d <sub>2</sub>	E	l <sub>1</sub>
800002675	2	15	6	7	27,0
800002676	3	18	8	12	31,0
800002677	4	25	12	15	40,5
800002678	5	28	13	22	45,5
800002679	6	40	18	28	63,5

\*Größe \*Size

### 8845

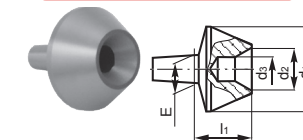

Artikel Nr. Code No.	W*	d <sub>1</sub>	d <sub>2</sub>	d <sub>3</sub>	E	l <sub>1</sub>
800002680	2	28	12	6	7	18,5
800002681	3	40	19	10	12	24,0
800002682	4	55	22	10	15	36,5
800002683	5	70	32	10	22	42,0
800002684	6	100	50	15	28	56,0

\*Größe \*Size

### 8846

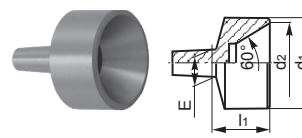

Artikel Nr. Code No.	W*	d <sub>1</sub>	d <sub>2</sub>	E	l <sub>1</sub>
800002904	2	28	24	7	21,5
800002905	3	40	35	12	26,5
800002906	4	55	48	15	39,0
800002907	5	70	63	22	47,0
800002908	6	100	90	28	62,0

\*Größe \*Size

1  
2  
3  
4  
5  
6  
7

8831-KPL