

8848

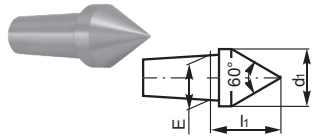

Artikel Nr. Code No.	W*	d ₁	E	l ₁
800002914	2	15	10	19
800002915	3	20	15	25
800002916	4	25	20	30
800002917	5	32	25	35
800002918	6	36	30	44

*Größe *Size

8849

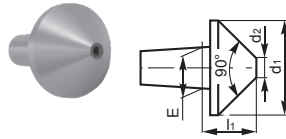

Artikel Nr. Code No.	W*	d ₁	d ₂	E	l ₁
800002919	2	22	3	10	15
800002920	3	36	6	15	22
800002921	4	45	10	20	25
800002922	5	56	14	25	30
800002923	6	70	18	30	36

*Größe *Size

8850

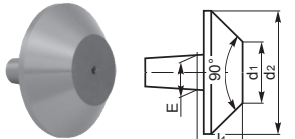

Artikel Nr. Code No.	W*	d ₁	d ₂	E	l ₁
800002924	2	37	18	10	15
800002925	3	63	33	15	22
800002926	4	70	35	20	25
800002927	5	80	38	25	30
800002928	6	100	50	30	36

*Größe *Size

8851

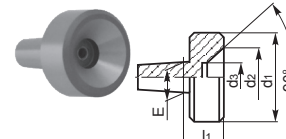

Artikel Nr. Code No.	W*	d ₁	d ₂	d ₃	E	l ₁
800002929	2	22	18	8	10	15
800002930	3	36	28	12	15	22
800002931	4	45	37	17	20	25
800002932	5	56	44	20	25	30
800002933	6	70	58	24	30	36

*Größe *Size

8852

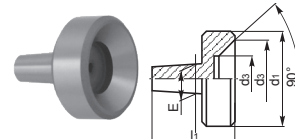

Artikel Nr. Code No.	W*	d ₁	d ₂	d ₃	E	l ₁
800002934	2	30	25	15	10	15
800002935	3	45	38	22	15	22
800002936	4	63	53	30	20	25
800002937	5	70	60	36	25	30
800002938	6	100	88	54	30	36

*Größe *Size

8853

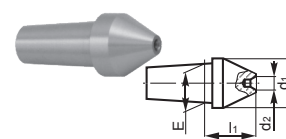

Artikel Nr. Code No.	W*	d ₁	d ₂	E	l ₁
800002939	2	15	1,25	10	15
800002940	3	20	1,25	15	22
800002941	4	25	2,5	20	25
800002942	5	32	2,5	25	30
800002943	6	36	4,0	30	36

*Größe *Size

8854

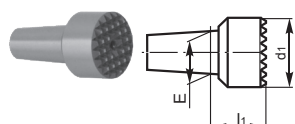

Artikel Nr. Code No.	W*	d ₁	E	l ₁
800002944	2	18	10	15
800002945	3	25	15	22
800002946	4	32	20	25
800002947	5	45	25	30
800002948	6	56	30	36

*Größe *Size

8855

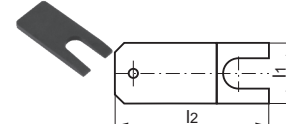

Artikel Nr. Code No.	W*	l ₁	l ₂
800002949	2	20	60
800002950	3	30	80
800002951	4	40	100
800002952	5	50	120
800002953	6	60	160

*Größe *Size



8832-KPL

- Mitlaufende Körnerspitze -
 Komplet-Satz mit austauschbaren
 Einsätzen
- Revolving tailstock centres
 with interchangeable inserts - set

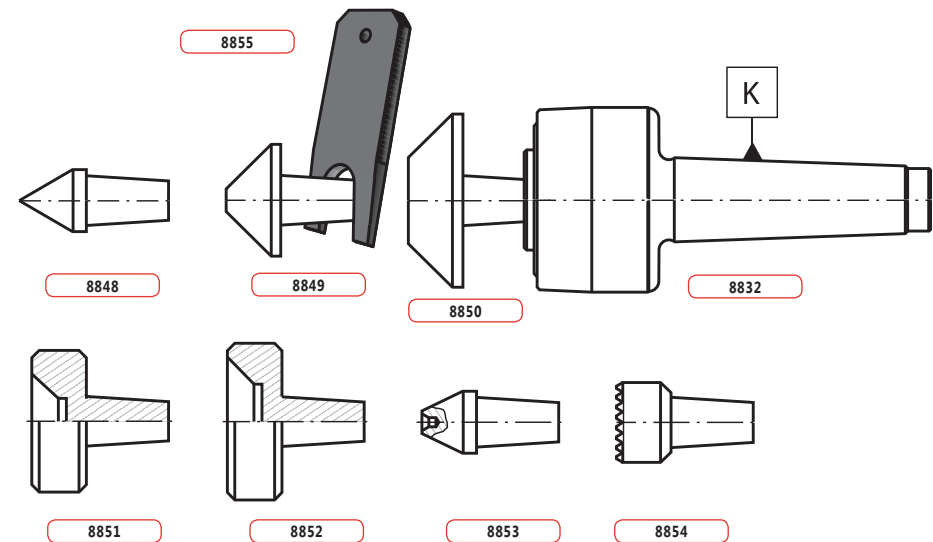

K MK	Gewicht max.	U/min.	Rundlaufabweichung	Artikel Nr.	Rundlaufabweichung	Artikel Nr.
			Max. concentr. error	Code No.	Max. concentr. error	Code No.
K MT	Max. weight	RPM	Präzision • Precision		Standard • Standard	
2	70	5000	0,010	800002635	0,020	800002636
3	120	4000	0,010	800002637	0,020	800002638
4	280	3000	0,010	800002639	0,020	800002640
5	650	2500	0,015	800002641	0,030	800002642
6	1200	2000	0,015	800002643	0,030	800002644